



PRECast POLE BASES

Faster, high quality and customizable

➤ **Faster and Easier to Install**

Atlas Precast Pole Bases are conduit-ready and use less time, labor and materials than site-cast or poured-in-place methods.

➤ **Consistently High Quality**

Our pole bases are constructed under climate-controlled conditions to guarantee a high standard of quality and finish.

➤ **Customizable to Your Exact Specs**

We know one size doesn't fit all. Base diameter, length, bolt patterns, ground wire, and conduit options can all be customized to your specs.



A BETTER, FASTER WAY TO CONSTRUCT POLE BASES



1 Remove base from delivery vehicle.



2 Attach lifting bracket to pole base.



3 Support lifting bracket with chains.



4 Lift pole base to vertical orientation.



5 Place into hole, run wiring through conduit.



6 Fill/tamp the hole and level the base.



NEED MORE
INFORMATION?



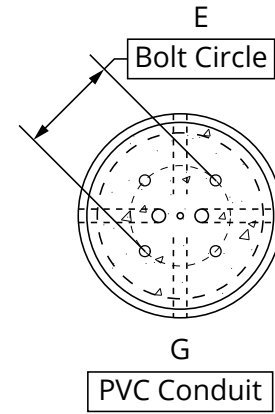
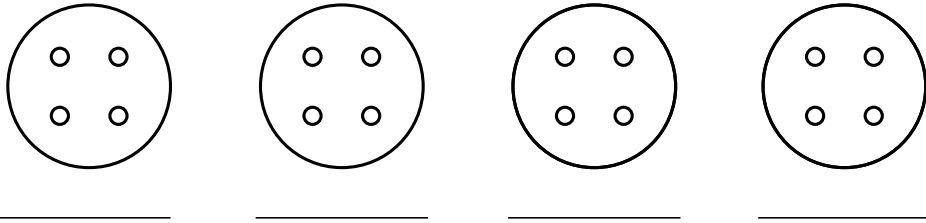

In order to ensure complete accuracy of the base, please include the engineering specification of the pre cast base.

Job Name _____

Location _____

Quantity _____ Total Weight _____

Notes _____

Height	Weight
4'-0"	2,925 Lbs
4'-6"	3,240 Lbs
5'-0"	3,655 Lbs
5'-6"	4,020 Lbs
6'-0"	4,390 Lbs
6'-6"	4,750 Lbs
7'-0"	5,120 Lbs
7'-6"	5,480 Lbs
8'-0"	5,850 Lbs
8'-6"	6,215 Lbs
9'-0"	6,580 Lbs
9'-6"	6,950 Lbs
10'-0"	7,310 Lbs
10'-6"	7,675 Lbs
11'-0"	8,040 Lbs

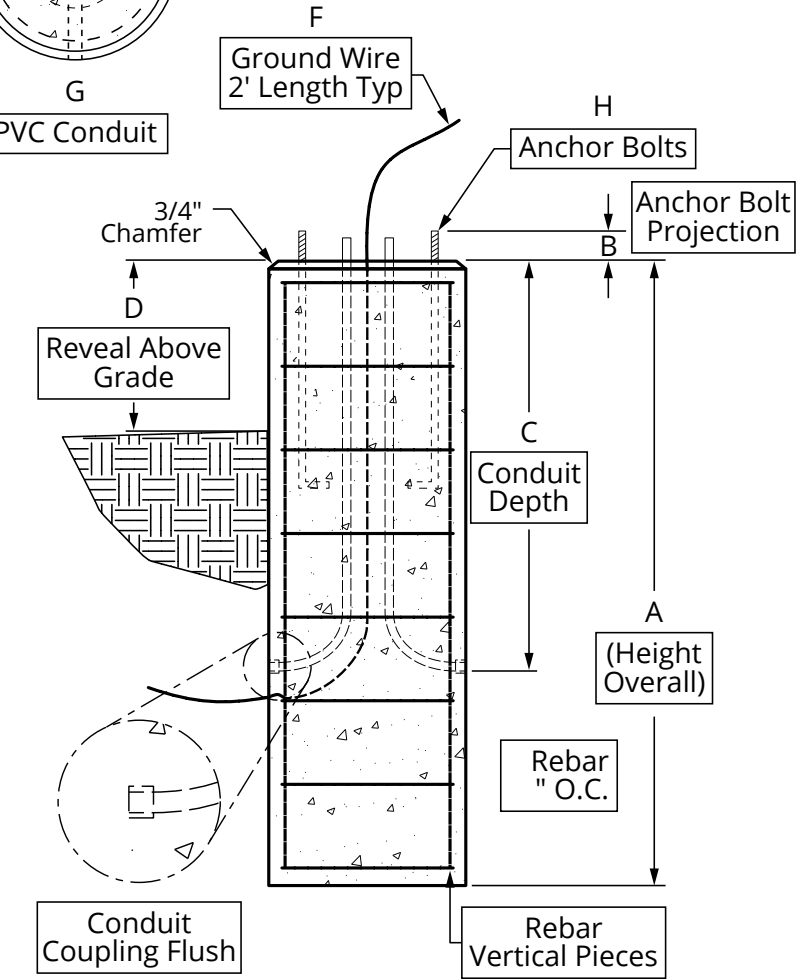

Dimensions:

A.) Total Base Height _____

B.) Bolt Projection _____

C.) Depth of Conduit _____

D.) Reveal Above Grade _____

E.) Bolt Circle Diameter _____

F.) Ground Wire - _____

G.) Conduit (PVC) _____

H.) Anchor Bolts - Dia & Length _____

General Notes:

- Concrete: $f_c = 5,000$ PSI @ 28 Days Min
- Reinforcing Steel: ASTM A615 Grade 60 Rebar

Job #: _____

Cust: _____

Signoff: _____

Date: _____

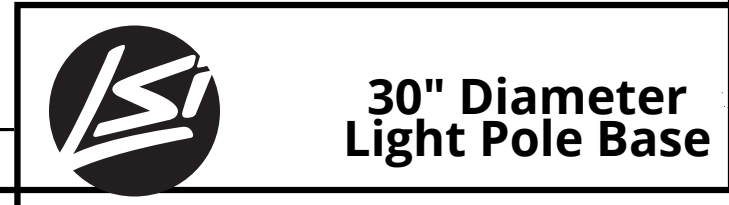

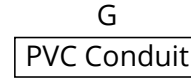
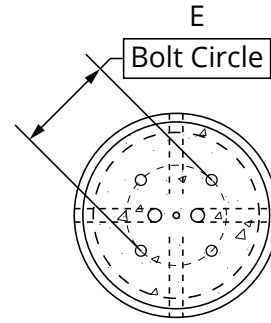
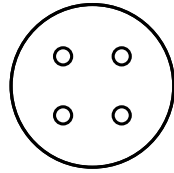
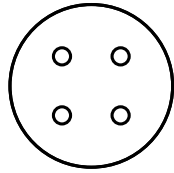
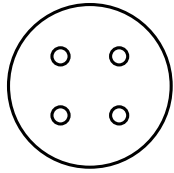
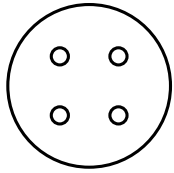

In order to ensure complete accuracy of the base, please include the engineering specification of the pre cast base.

Job Name _____

Location _____

Quantity _____ Total Weight _____

Notes _____

Height	Weight
2'-0"	540 Lbs.
2'-6"	675 Lbs
3'-0"	800 Lbs
3'-6"	930 Lbs
4'-0"	1,065 Lbs
4'-6"	1,200 Lbs
5'-0"	1,330 Lbs
5'-6"	1,465 Lbs
6'-0"	1,600 Lbs
6'-6"	1,730 Lbs
7'-0"	1,860 Lbs
7'-6"	2,000 Lbs
8'-0"	2,130 Lbs
8'-6"	2,260 Lbs
9'-0"	2,400 Lbs

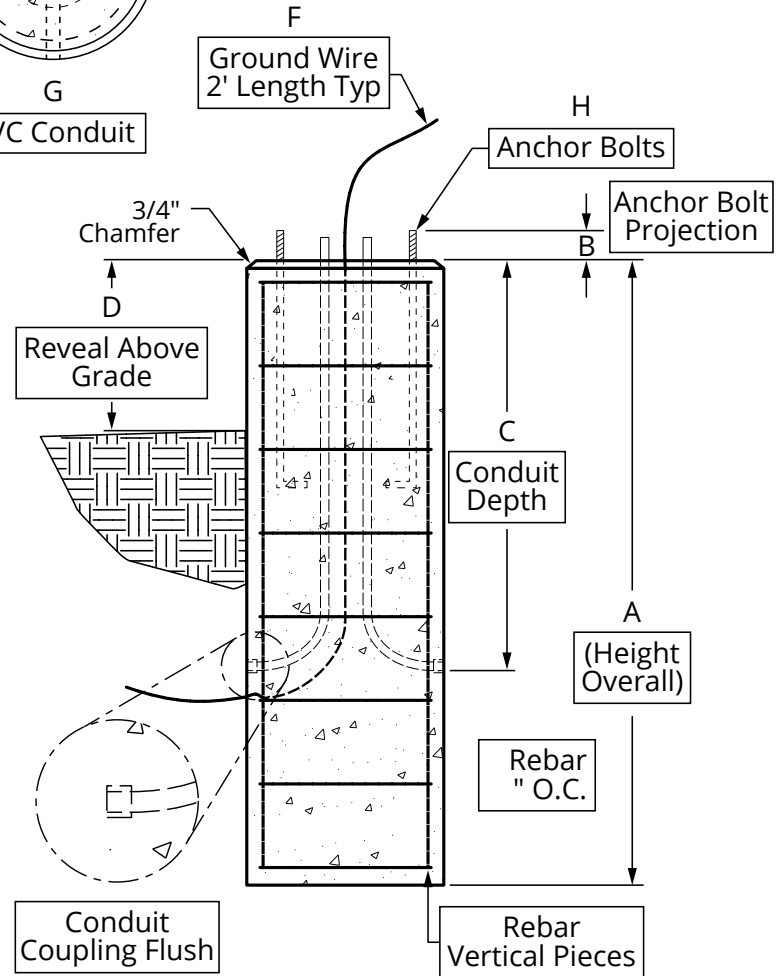

Dimensions:

- A.) Total Base Height _____
- B.) Bolt Projection _____
- C.) Depth of Conduit _____
- D.) Reveal Above Grade _____
- E.) Bolt Circle Diameter _____
- F.) Ground Wire - _____
- G.) Conduit (PVC) _____
- H.) Anchor Bolts - Dia & Length _____

Job #: _____

Cust: _____

Signoff: _____

Date: _____

General Notes:

1. Concrete: $f_c = 5,000$ PSI @ 28 Days Min
2. Reinforcing Steel: ASTM A615 Grade 60 Rebar



**18" Diameter
Light Pole Base**

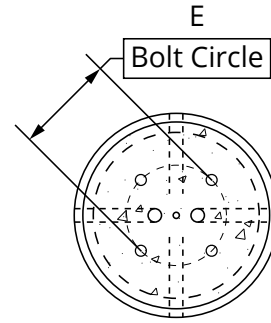
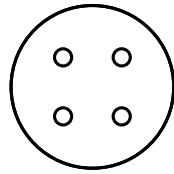
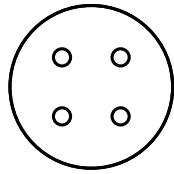
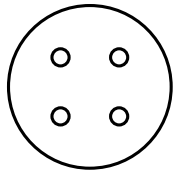
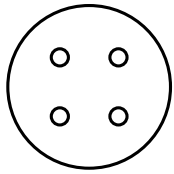

In order to ensure complete accuracy of the base, please include the engineering specification of the pre cast base.

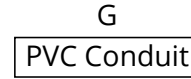

Job Name _____

Location _____

Quantity _____ Total Weight _____

Notes _____

Height	Weight
3'-0"	1,405 Lbs.
3'-6"	1,640 Lbs
4'-0"	1,870 Lbs
4'-6"	2,100 Lbs
5'-0"	2,340 Lbs
5'-6"	2,575 Lbs
6'-0"	2,810 Lbs
6'-6"	3,040 Lbs
7'-0"	3,275 Lbs
7'-6"	3,510 Lbs
8'-0"	3,745 Lbs
8'-6"	3,980 Lbs
9'-0"	4,215 Lbs
9'-6"	4,450 Lbs
10'-0"	4,680 Lbs
10'-6"	4,915 Lbs
11'-0"	5,150 Lbs
11'-6"	5,385 Lbs

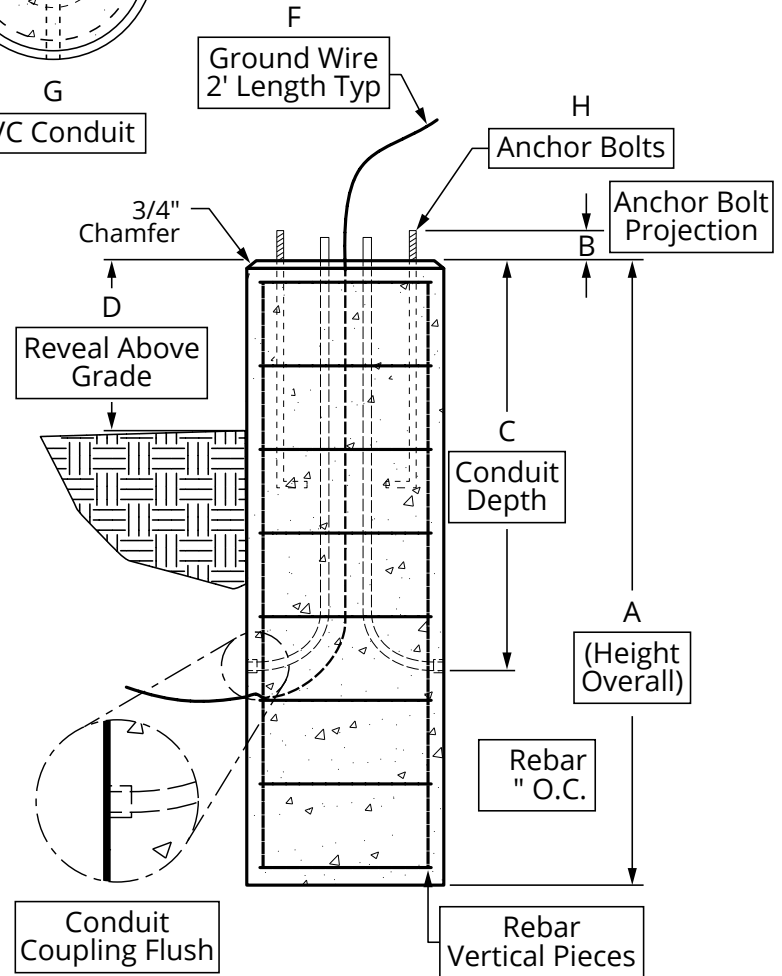

Dimensions:

- A.) Total Base Height _____
- B.) Bolt Projection _____
- C.) Depth of Conduit _____
- D.) Reveal Above Grade _____
- E.) Bolt Circle Diameter _____
- F.) Ground Wire - _____
- G.) Conduit (PVC) _____
- H.) Anchor Bolts - Dia & Length _____

Job #: _____

Cust: _____

Signoff: _____

Date: _____

General Notes:

1. Concrete: $f_c = 5,000$ PSI @ 28 Days Min
2. Reinforcing Steel: ASTM A615 Grade 60 Rebar



24" Diameter Light Pole Base